

C2020®

CANYON LINE BY VENTUS AIR

The air ventilation system for ducted air-conditioning, C2020, is an exclusive innovative idea developed by D.Ellinas Factory Products Ltd. It operates as a complete system designed with a plenum box and spigots to ensure zero air loss, resulting in a flawless design. The product can be installed on the ceiling or wall-mounted.

ALIGNMENT

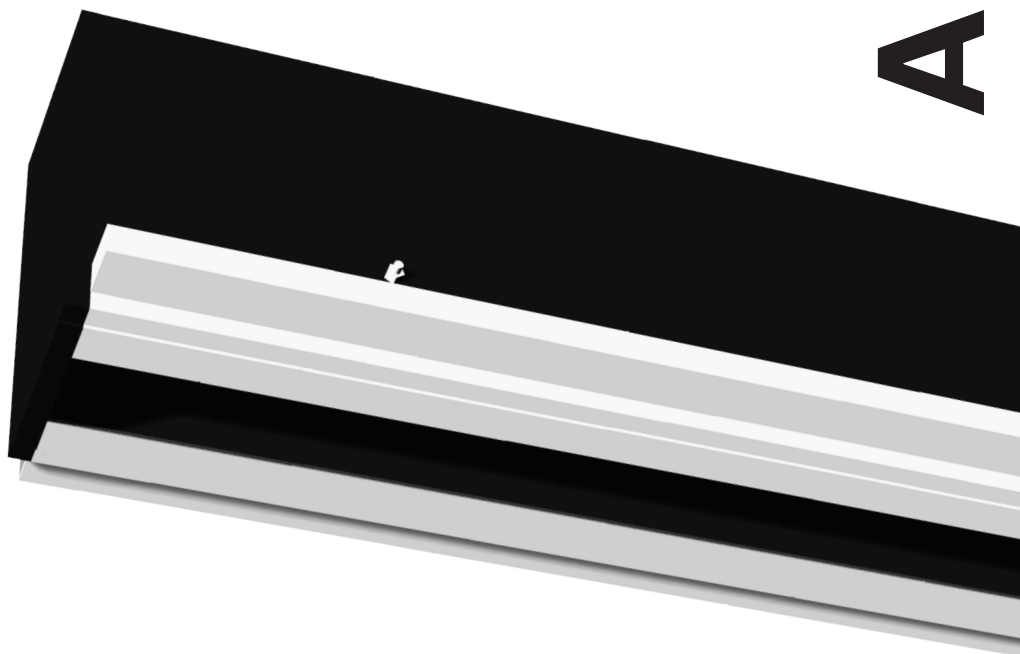

1 ALIGNMENT PROCESS

Step 1

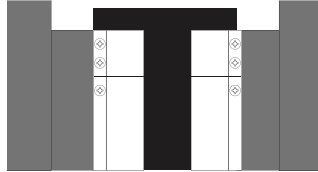

Step 2

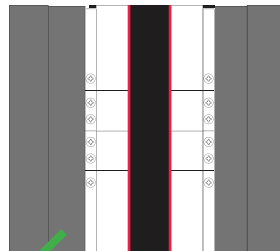
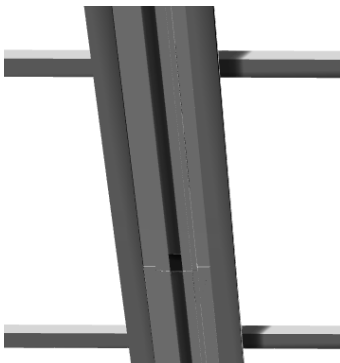
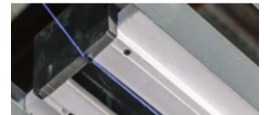
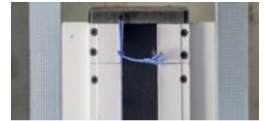
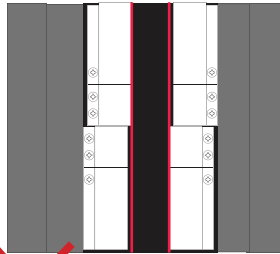
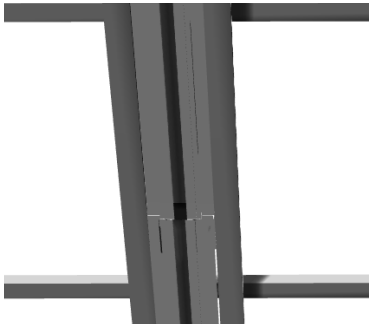

Step 3



2 FINISHING PROCESS

Step 1



Step 2

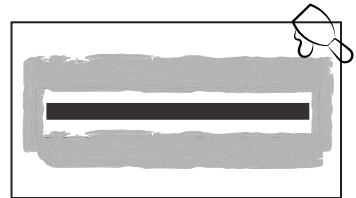

Step 3



Step 4



Step 5



Step 6

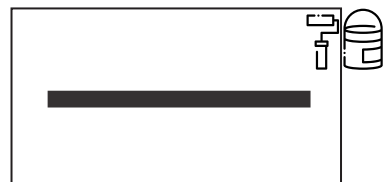

DISASSEMBLY INSTRUCTIONS

Step 1

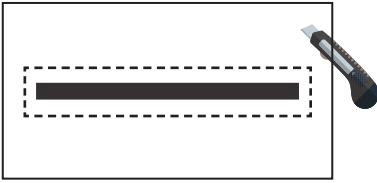

Step 2

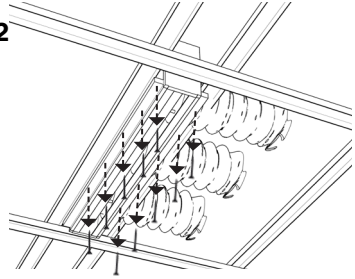

Step 3

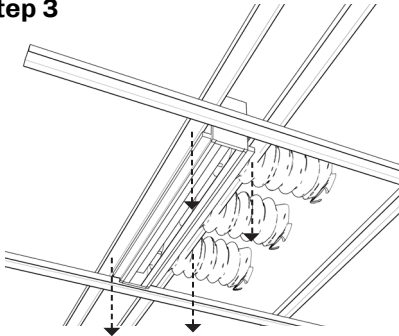

Step 4

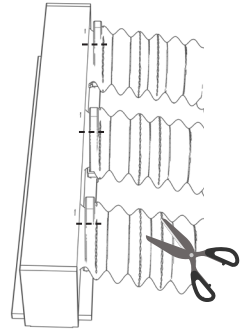

Step 5

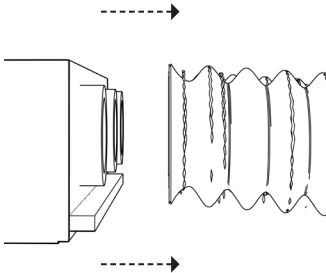

Step 6

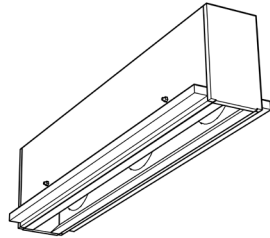

Give Your Product a New Life!

All D.Ellinas products are designed to be disassembled for either reuse or recycling.

www.c2020.eu

Copyright © C2020® is a brand of D.Ellinas Factory Products Ltd®, protected by European and International laws pertaining to intellectual property.

D.Ellinas Factory Products is a registered company in Cyprus (reg. no. HE260375)